



PLI 353

ALL-PURPOSE



www.mottura.com



PLÌ 353/1



PLÌ 353/2



PLÌ 353/3

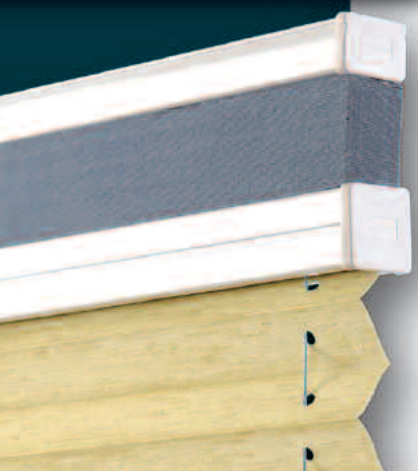

PLÌ 353/3



PLÌ 353/4

TENDE PLISSETTATE

Minimo ingombro - Il minimo ingombro di Plì 353 permette l'applicazione dove gli spazi sono molto ridotti come serramenti scorrevoli, lucernari basculanti, imbarcazioni e varie tipologie di veicoli.

Versatilità - Plì 353 è un prodotto estremamente versatile ed anche l'unico adatto per arredare serramenti dalle geometrie più diverse.

Azionamenti - Plì 353 prevede i seguenti differenti azionamenti: a corde, monocomando o a motore 24 Vdc. Nella versione 353/3 l'azionamento singolo o multiplo permette la movimentazione dal basso verso l'alto o viceversa.

Black out - Con i tessuti cellulari, Plì 353 è un prodotto black out 100%.

Tessuti antimacchia - I sistemi Plì 353 adottano i tessuti della collezione Hi-tex Mottura che vengono sottoposti a trattamento antimacchia garantendo così una lunga vita del prodotto.

PLEATED BLINDS

Minimum overall - Plì 353 minimum overall allows its application where spaces are very limited as sliding doors and windows, skylights overhead, boats, and various kinds of vehicles.

Versatility - Plì 353 is an extremely versatile product it is also the only suitable for furnishing frames with different geometries.

Drives - Plì 353 provides the following drives: cord drawn, monocontrol chain operating or motorized 24 Vdc. In the version 353/3 the single or multiple operating allows handling from the bottom upwards or vice versa.

Black out - Using cellular fabrics Plì 353 is a 100% black out device.

Stainless treatment - Plì 353 adopts Hi-Tex Mottura Collection fabrics with stainless treatment that ensures a long life to the product.

Giorno e notte

Pli 353/3 permette di arredare la finestra con il tessuto doppio filtrante ed oscurante per generare l'effetto giorno/notte, anche in questa configurazione l'azionamento può essere sia verso il basso che verso l'alto.

Night&day

Pli 353/3 allows to furnish the window with the double fabric filter and obscuring to generate the day/night effect. Even in this configuration the operation can be both downward and upward.

Multistop

Pli 353/3 è il prodotto ottimale per il controllo della luce in quanto permette l'arresto del sistema in qualsiasi punto movimentando la tenda in entrambe le direzioni.

Multistop

Pli 353/3 is the best solution to modulate the light

because it allows the system arrest in any point moving the blind in both directions.

Tecnologia

Pli 353 nella configurazione con azionamento a catenella per tende grandi è dotato di un meccanismo demoltiplicato (rapporto 1:4) che riduce lo sforzo dell'azionamento.

Technology

Pli 353, in chain operating version for large blinds has a geared down drive

(1:4 ratio); this device strongly reduces the effort to action heavy weight blinds.

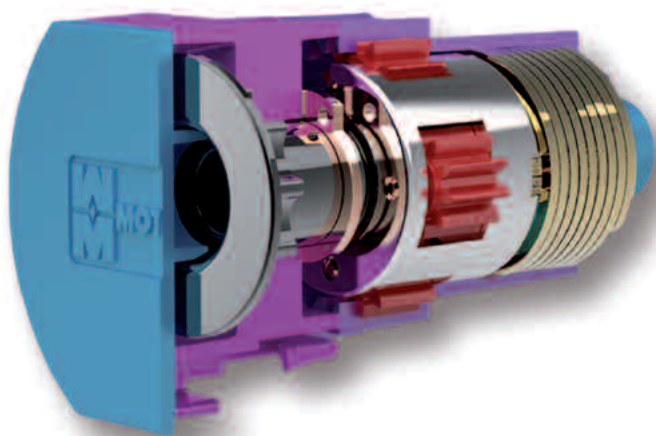

Monocomando

Nella versione Pli 353 con azionamento a catenella la movimentazione avviene tramite rocchetti avvolgintro che garantiscono la perfetta risalita orizzontale della tenda.

Single command operation

In the version Pli 353 with monocontrol drive chain handling happens through tape winding spools which guarantee the perfect horizontal lift of the blind.

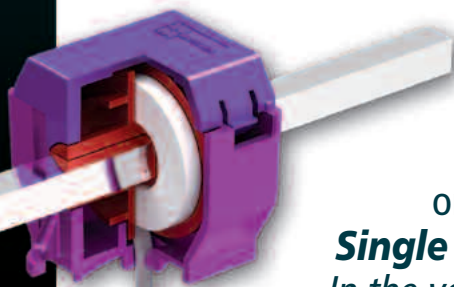

FORME E SOLUZIONI SHAPES AND SOLUTIONS

PLÌ 353/1 - AZIONAMENTO A CORDA/CORD OPERATING

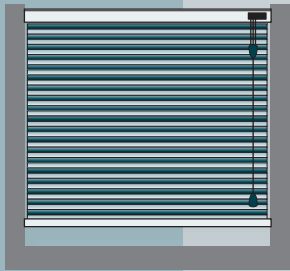

STANDARD

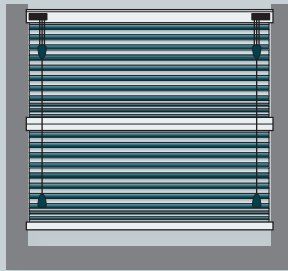

B

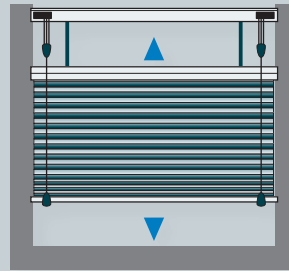

C

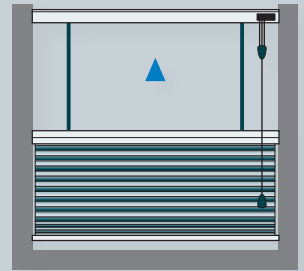

D

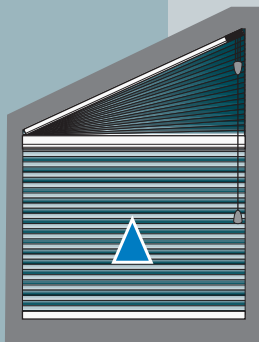

E

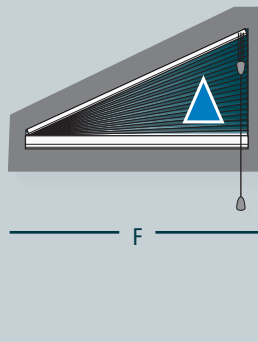

F

PLÌ 353/2 - AZIONAMENTO A CATENELLA/ CHAIN OPERATING

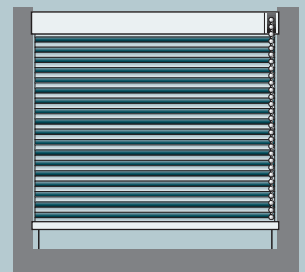

CON GUIDE / GUIDED BLINDS

PLÌ 353/3 - AZIONAMENTO MANUALE/MANUAL OPERATING

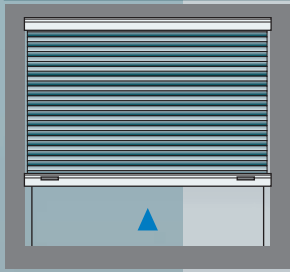

STANDARD

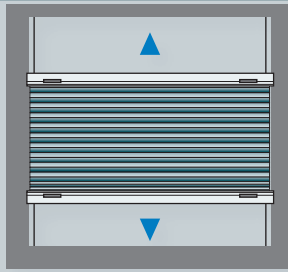

B

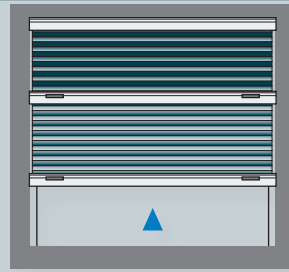

C

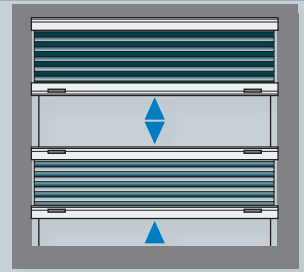

D

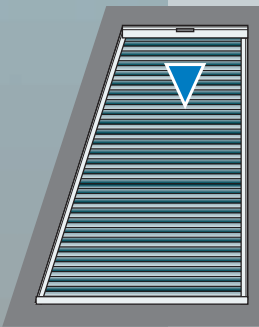

E

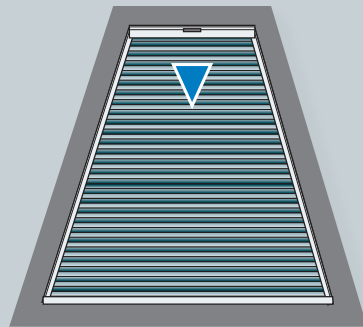

F

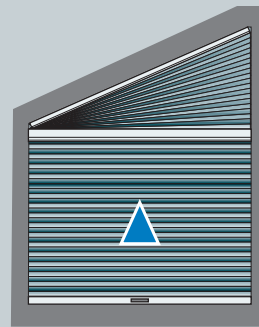

G

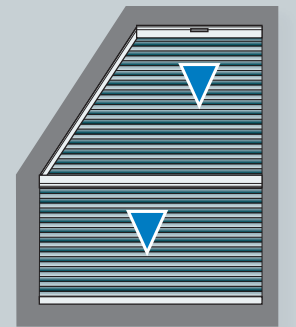

H

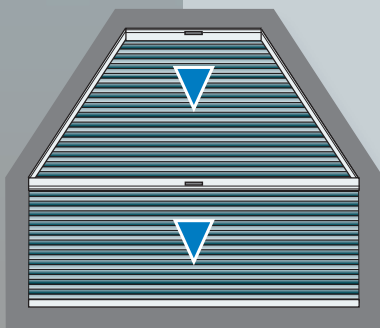

I

PLÌ 353/4 - AZIONAMENTO A MOTORE/ MOTORISED OPERATING

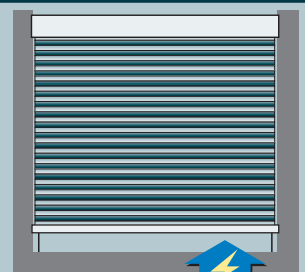

CON GUIDE / GUIDED BLINDS

INSTALLAZIONI INSTALLATIONS

PLÌ 353/1

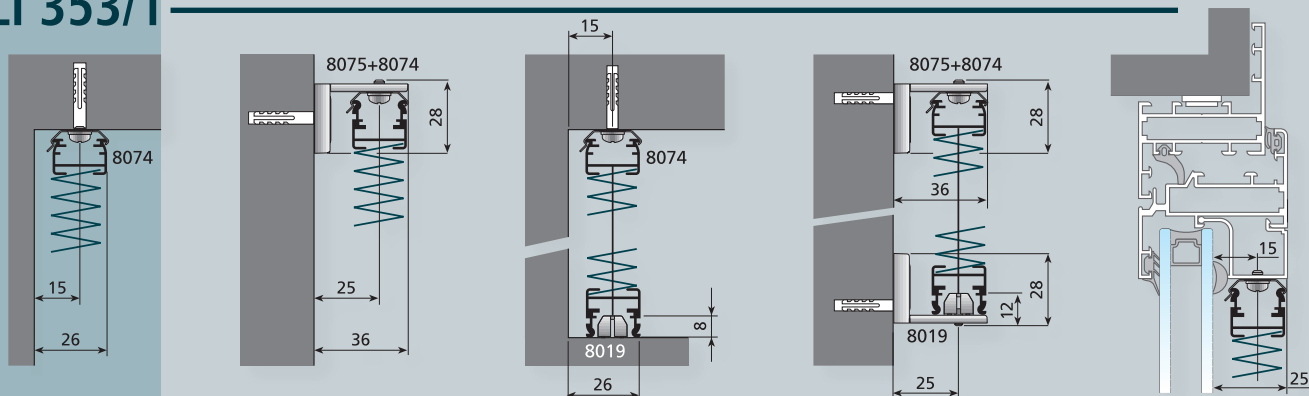

PLÌ 353/2 e PLÌ 353/4

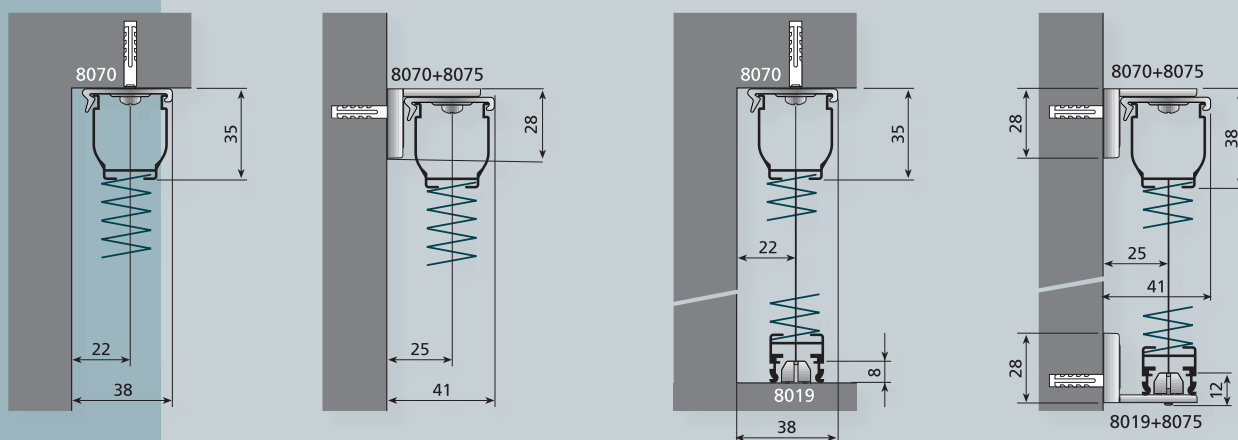

PLÌ 353/3

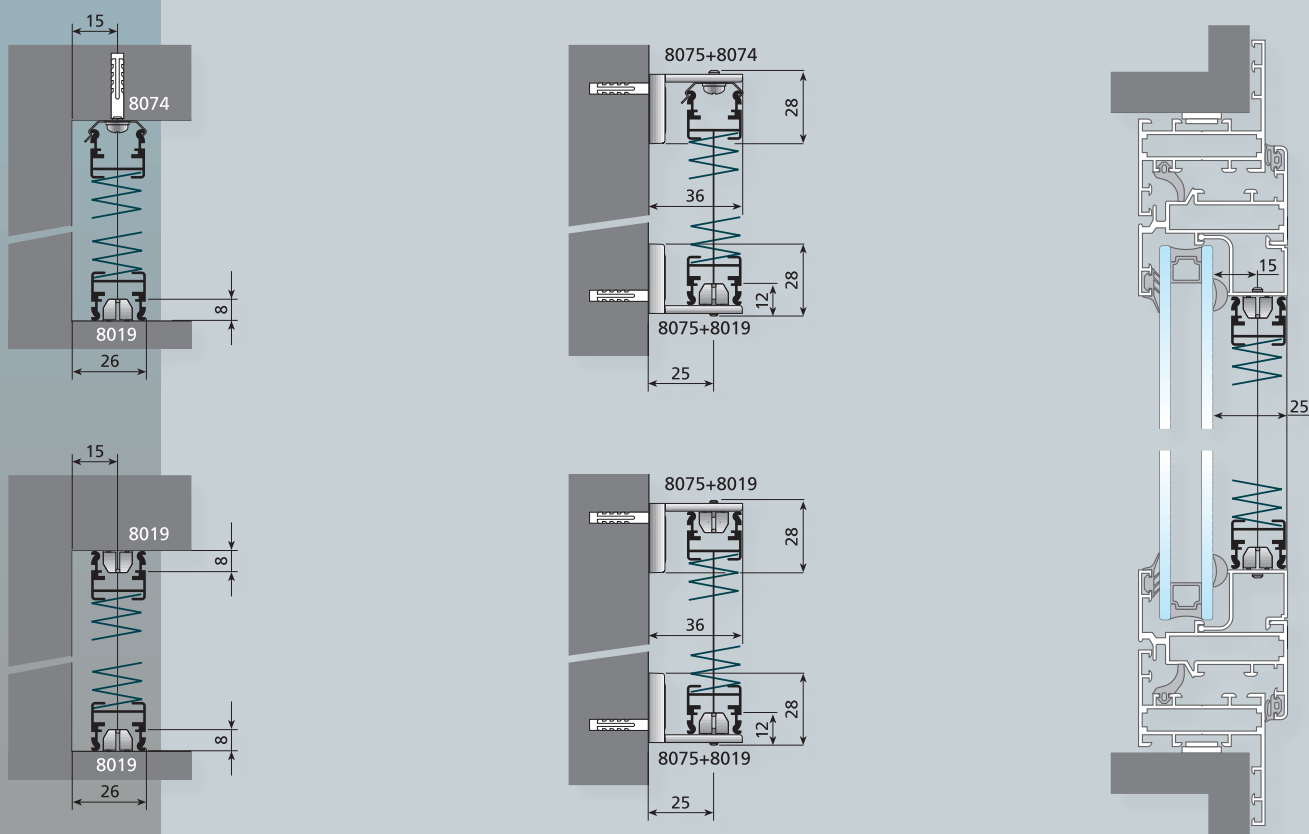

LUCERNARI SKYLIGHTS



PLÌ 353/3

Plì 353/3 è la tenda plissè per lucernari che può essere installata su qualsiasi tipo di serramento sia standard che su misura. Una soluzione esclusiva permette di installare Plì 353/3 indifferentemente su serramenti a 90° e 96°. Plì 353/3 è un sistema frizionato multi arresto che permette di modulare la luce sia manualmente, sia tramite l'asta di comando indicata per i lucernari che non permettono un azionamento manuale. Plì 353/3 è disponibile sia con tessuti filtranti che oscuranti.

Plì 353/3 is the pleated blind version for skylights that can be installed on any type of frame both standard and custom made. An exclusive solution allows you to install Plì 353/3 indifferently on frames at 90° and 96°.

Plì 353/3 is a multistop system that allows you to modulate the light manually or through the control rod for the skylights not operable manually. Plì 353/3 is available both with filtering fabrics than 100% black out.

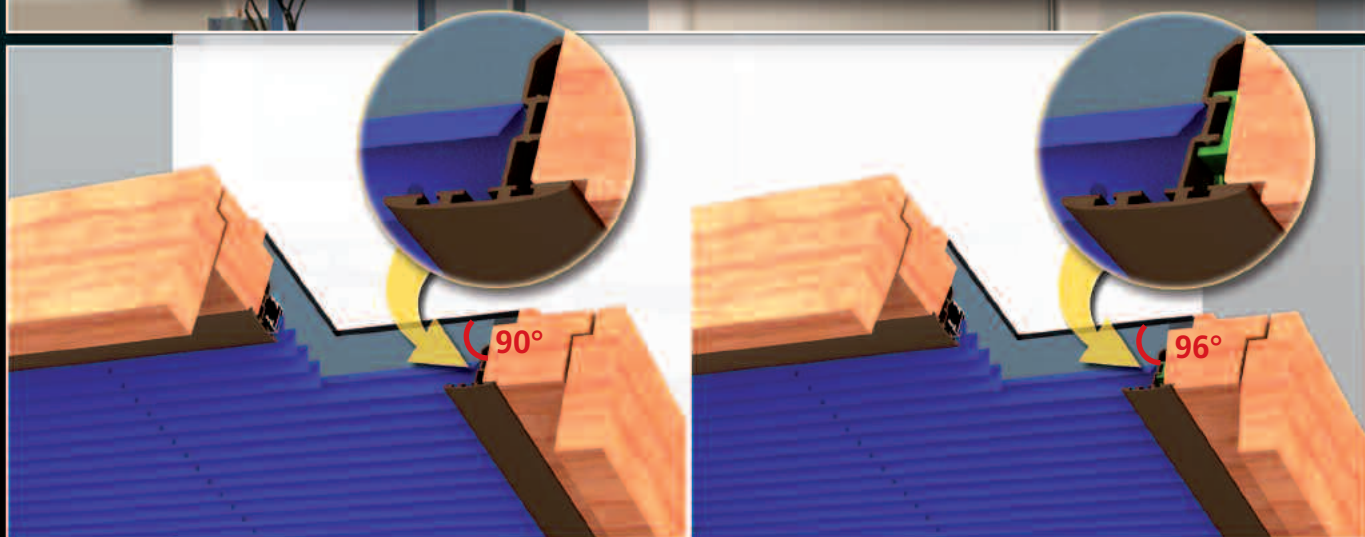

LUCERNARI SKYLIGHTS



GARDEN 436

Garden 436 è un sistema plissé per lucernari orizzontali o inclinati disponibile in tre versioni:

- Garden 436/1 azionamento a catenella
- Garden 436/2 azionamento ad argano
- Garden 436/3 motorizzato 24 Vdc

Garden 436 è un prodotto tecnologicamente raffinato ed il suo perfetto funzionamento è garantito dalle cinghie forate che corrono all'interno dei profili laterali garantendo il perfetto parallelismo del tessuto.

Garden 436 è indicato per sistemi di larghezza non superiore a 200 cm e di lunghezza entro i 400 cm.

Garden 436 is Pleated blind system for horizontal or slooped skylights for filtering, dim out and 100% black out available in 3 versions:

- Garden 436/1 chain operating
- Garden 436/2 crank operating
- Garden 436/3 motorized

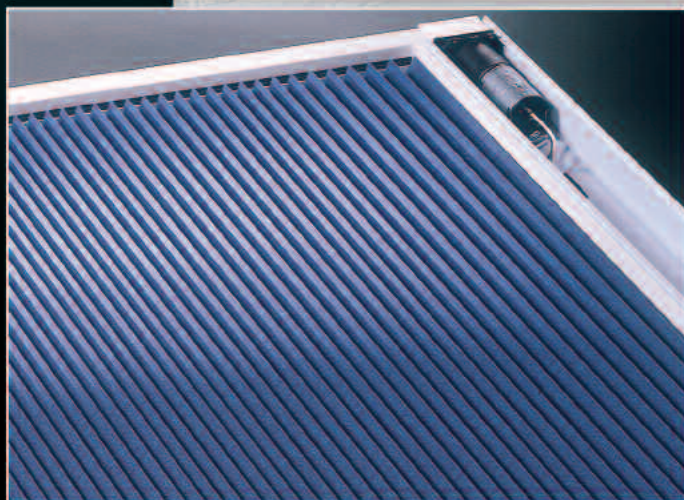

Garden 436 is a product technologically refined and its perfect operation is ensured by punched belts that run inside the lateral profiles by ensuring the perfect parallelism of the blind.

Garden 436 is suitable for systems of a width not exceeding 200 cm and a length within the 400 cm.

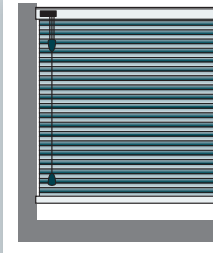
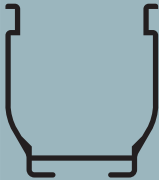
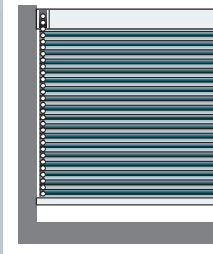

LA GAMMA

THE RANGE

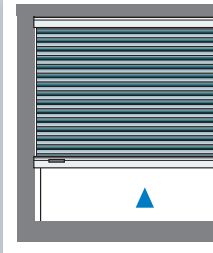
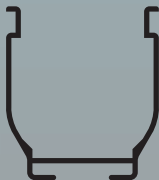
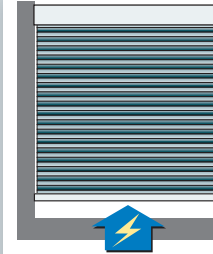
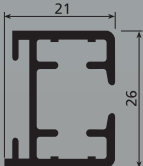
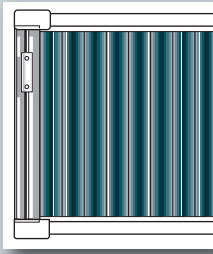
SISTEMA system	AZIONAMENTO operation	TESSUTI - fabrics				INSTALLAZIONE - installation				FORME SPECIALI special shapes
		FILTRANTI filtering	ATTENUANTI dim-out	OSCURANTI black-out	CELLULARI cellular	SOFFITTO Ceiling	PARETE wall	INCASSO frame	LUCERNARI skylight	
Pli 353/1  Art./Ref. 353	corda cord operating 	●	●	●	●	●	●	●	●	
Pli 353/2  Art./Ref. 356	catena chain operating 	●	●	●	●	●	●	●		
Pli 353/3  Art./Ref. 355	manuale manual operating 	●	●	●	●	●	●	●	●	●
Pli 353/4  Art./Ref. 356	motorizzata motorized 	●	●	●	●	●	●	●		
Garden 436  Art./Ref. 401/..		●	●	●	●	●	●	●	●	